

FPS(S), FPW(S)

Robustes Fußpedal mit Alu-Guss-Gehäuse

Stabiles Fußpedal mit großer, geriffelter Aluminiumtrittplatte und Schaltkontakten für maximal 4 Schaltstufen (FPS) oder mit Potentiometer und Richtungskontakten (FPW). Optional mit Schutzhaube (S).

FPS, FPSS: IP 42 $\frac{250\text{ V}\sim}{16\text{ A}}$ $\frac{30\text{ V}=\}{1\text{ A}}$

FPW, FPWS: IP 42 $\frac{250\text{ V}\sim}{5\text{ A}}$ $\frac{30\text{ V}=\}{3\text{ A}}$

FPS
FPW

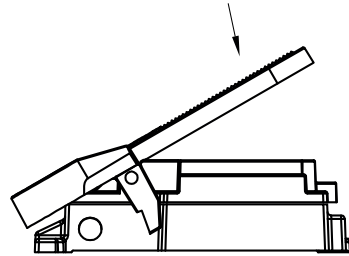
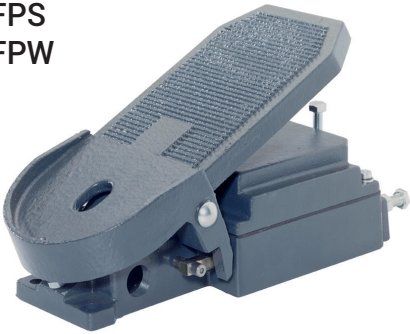

FPSS
FPWS

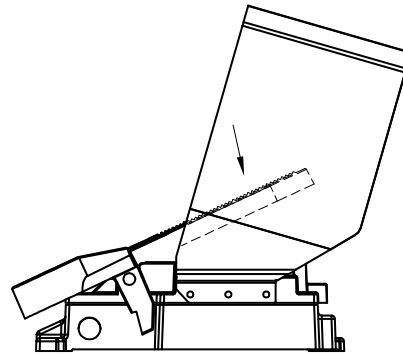

Typenschlüssel

Abmessungen siehe Maßblatt TI-F-1

Typenschlüssel: FPS
FPSS F...
Baugröße ———
Kontaktsatz ———

	Kontaktsatz		Potentiometer (inklusive Anbau)	
FPS FPSS	F30	F40		
FPW FPWS	A E	AE	PW70d-5K	

Typenschlüssel: FPW A PW70d-...
FPWS E
Baugröße ——— AE
Kontaktsatz ———
Potentiometer ———

Kontaktsätze

F30:

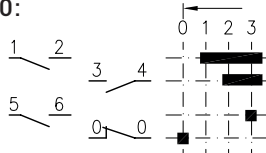

F40:

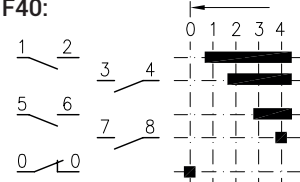

A:

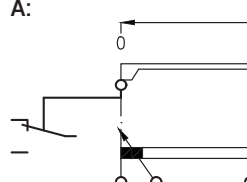

E:

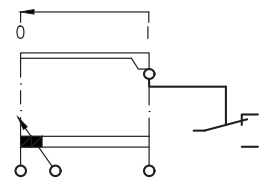

Fußtaster SF
foot pedal

SF_ Schutzart IP42
degree of protection IP42

SF_0d Schutzart IP56
degree of protection IP56

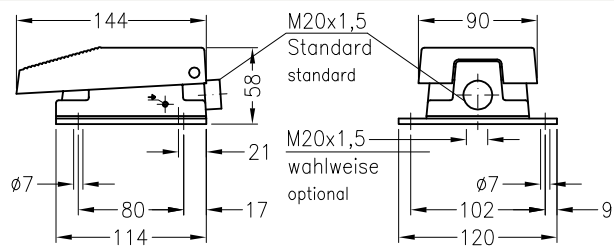

Fußtaster FPS/FPW
foot pedal

Schutzart IP42
degree of protection IP42

